

Henry's Bench

a place for the electronic hobbyist

Menu ▾

KEYES KY-040 ARDUINO ROTARY ENCODER USER MANUAL

Contents [\[show\]](#)



The Keyes KY-040 Rotary Encoder

The Keyes KY-040 rotary encoder is a rotary input device (*as in knob*) that provides an indication of how much the knob has been rotated AND what direction it is rotating in.

Its a great device for stepper and servo motor control. You could also use it to control devices like digital potentiometers.

Rotary Encoder Basics

A rotary encoder has a fixed number of positions per revolution. These positions are easily felt as small "clicks" you turn the encoder.

The Keyes module that I have has thirty of these positions.



On one side of the switch, there are three pins. They are normally referred to as A, B and C. In the case of the KY-040, they are oriented as shown.

Inside the encoder there are two switches. Once switch connects pin A to pin C and the other switch connects pin B to C.

In each encoder position, both switches are either opened or closed. Each click causes these switches to change states as follows:

- **If both switches were closed**, turning the encoder either clockwise or counterclockwise one position will cause both switches to open
- **If both switches are open**, turning the encoder either clockwise or counterclockwise one position will cause both switches to close.

The illustration below is representative of how the switch is constructed.

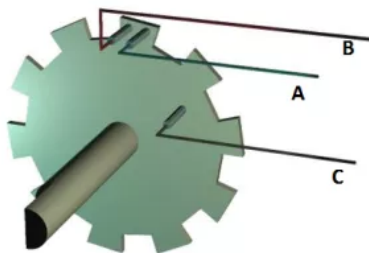

As you can see, the angular position of the A terminal and the B terminal is such that:

- **Rotating the switch clockwise** will cause the switch connecting A and C to change states first.
- **Rotating the switch counterclockwise** will cause the switch connecting B and C to change states first.

If we were to represent the opening a closing of the switches as wave forms, it would look something like this.

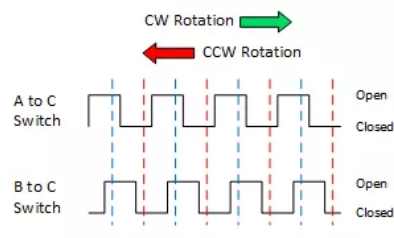

WELCOME!!

[Privacy Policy](#)

[About Me](#)

ON EBAY...

ON AMAZON...

TOP POSTS & PAGES



[The ACS712 Current Sensor with an Arduino](#)



[ACS712 Current Sensor User Manual](#)



[MAX31855 Arduino K Thermocouple Sensor: Manual and Tutorial](#)



[Keyes KY-040 Arduino Rotary Encoder User Manual](#)



[U8glib Arduino OLED Tutorial 1: Hello World on Steroids](#)

FOLLOW ME ON TWITTER

Tweets

[Follow](#)



Capn Fatz
@CaptainFatz

1 Jun

Simple and straightforward.

henrysbench.capnfatz.com/henrys-bench/a...



Capn Fatz
@CaptainFatz

31 May

Playing Music on CNC

crazymakerprojects.capnfatz.com/playing-music-...
pic.twitter.com/M2oLcFsmfc



Capn Fatz
@CaptainFatz

28 May

Arduino Goofy Eyes

crazymakerprojects.capnfatz.com/arduino-goofy-...
pic.twitter.com/MMWpRKD55i



Both Open
Both Closed
Both Open
Both Closed
Both Open
Both Closed
Both Open
Both Closed

Essentially, determining which switch changed states first is how the direction of rotation of rotating is determined.

If A changed states first, the switch is rotating in a clockwise direction.

If B changed states first, the switch is rotating in a counter clockwise direction.

KY-040 Pin Outs

The pin outs for this rotary encoder are identified in the illustration below.

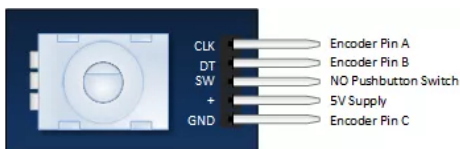

The module is designed so that a low is output when the switches are closed and a high when the switches are open.

The low is generated by placing a ground at Pin C and passing it to the CLK and DT pins when switches are closed.

The high is generated with a 5V supply input and pullup resistors, such that CLK and DT are both high when switches are open.

Not previously mentioned is the existence of of push button switch that is integral to the encoder. If you push on the shaft, a normally open switch will close. The feature is useful if you want to change switch function. For example, you may wish to have the ability to between coarse and fine adjustments.

Keys Rotary Encoder Schematic

A schematic for this module is provided below. R2 and R3 in the schematic are pull up resistors.

Click on it for a bigger view.

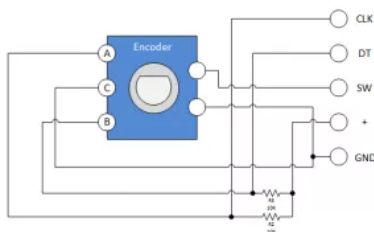

Keys KY-040 Evaluation Circuit

Successfully implementing the Rotary Encoder into any project requires a clear understanding of everything that has been discussed thus far. If you're still a little fuzzy, you may wish to throw together the evaluation circuit illustrated below:

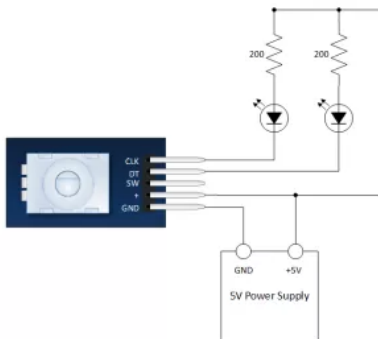

VERY SLOWLY rotate then encoder shaft both clockwise and counterclockwise. Notice which LEDs change state first with rotation.

KY-040 Arduino Tutorial

Module Connection to the Arduino

Pretty straight forward... All you need to do is connect four wires to the module.



Capn Fatz @CaptainFatz 27 May
1000W Battery Powered LED Flashlight
crazymakerprojects.capnfatz.com/1000w-battery-...
pic.twitter.com/SZKGSfAIUB



Capn Fatz @CaptainFatz 25 May
Arduino Coca Cola Can Piano
crazymakerprojects.capnfatz.com/arduino-coca-c...
pic.twitter.com/jdcxXjW16N



Tweet to @CaptainFatz

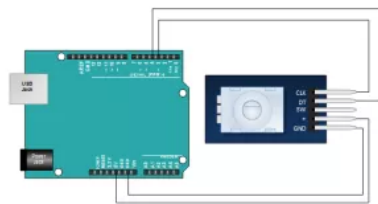

The Arduino Sketch

This is a simple sketch that shows how to count the encoder position and how to determine direction of rotation. It has no switch debounce, nor does it use interrupts. A fully developed application might need to incorporate these in order to make it robust.

```
int pinA = 3; // Connected to CLK on KY-040
int pinB = 4; // Connected to DT on KY-040
int encoderPosCount = 0;
int pinALast;
int aVal;
boolean bcw;

void setup() {
  pinMode (pinA,INPUT);
  pinMode (pinB,INPUT);
  /* Read Pin A
  Whatever state it's in will reflect the last position
  */
  pinALast = digitalRead(pinA);
  Serial.begin (9600);
}

void loop() {
  aVal = digitalRead(pinA);
  if (aVal != pinALast){ // Means the knob is rotating
    // if the knob is rotating, we need to determine direction
    // We do that by reading pin B.
    if (digitalRead(pinB) != aVal) { // Means pin A Changed first - We're Rotating
      encoderPosCount ++;
      bcw = true;
    } else { // Otherwise B changed first and we're moving CCW
      bcw = false;
      encoderPosCount--;
    }
    Serial.print ("Rotated: ");
    if (bcw){
      Serial.println ("clockwise");
    }else{
      Serial.println("counterclockwise");
    }
    Serial.print("Encoder Position: ");
    Serial.println(encoderPosCount);
  }
  pinALast = aVal;
}
```

Share this:



ADD A COMMENT

Your email address will not be published. Required fields are marked *

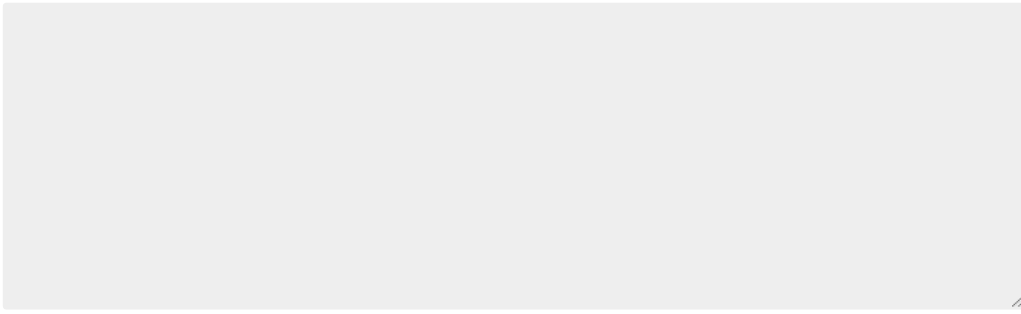

ADD COMMENT